



AQUA-AEROBIC SYSTEMS, INC.

Aqua-Jet[®]

SURFACE MECHANICAL AERATOR

Aqua-Jet®

SURFACE MECHANICAL AERATOR

The Aqua-Jet® aerator is the most durable, highly efficient wastewater aerator on the market today. Since 1969, more than 80,000 Aqua-Jet aerators have been installed throughout the world, representing 1.5 million horsepower and over 9 billion hours of runtime.

The robust design and use of the highest quality materials have also made the Aqua-Jet the most trusted aerator in the industry, outlasting other aerators 2 to 1.

Features and Advantages

- Vibration limiting design; velocity of 0.3 inches/second or less
- Proven oxygen and mixing performance
- Easy and flexible installation
- Short lead times
- Easily incorporated into existing plants
- Units are retrievable for easy access
- Various mooring arrangements available
- Endura® Series low maintenance motors save energy, reduce O&M costs and increase performance

Aqua-Jet® Components

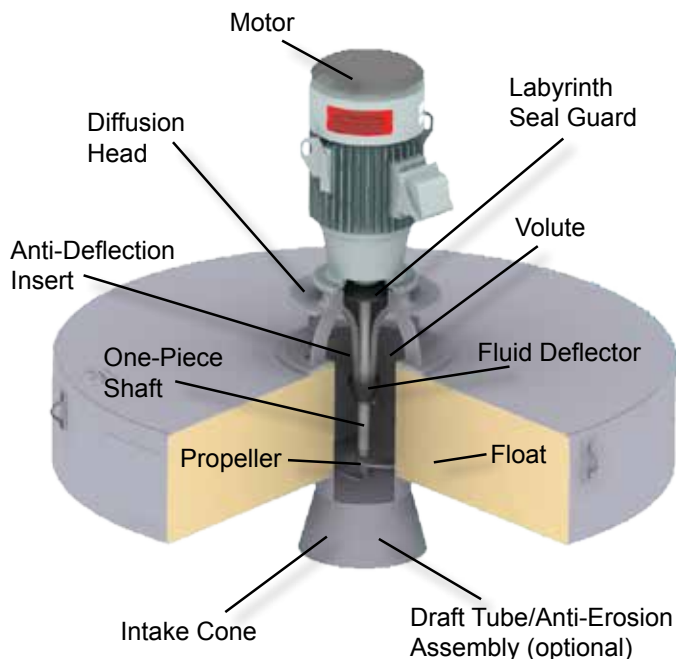

Aqua-Jet® Operation

The Aqua-Jet aerator is a mechanical direct-drive unit designed to provide optimum oxygen transfer in a variety of municipal and industrial wastewater applications. The performance of the Aqua-Jet aerator also provides the mixing necessary to uniformly disperse oxygen and organic matter within the microbial population.

How it Works

Basin water is pumped up into the intake cone and through the volute, and is dispersed through the diffusion head in a spray pattern. Oxygenation occurs at two critical points: **1)** when the water exits the diffusion head and **2)** when the spray enters the water surface.



Typical Aqua-Jet® aerator operation.

Motor - standard 3-year warranty, severe duty, totally enclosed fan-cooled (TEFC), Class F insulation, 1.15 service factor

Diffusion Head - monolithic casting, 304 stainless steel (ss), limits vibration

Motor Shaft - one-piece, 17-4 precipitation hardened (PH) ss, eliminates couplings

Float - Fiberglass or 304 ss exterior. Interior closed-cell polyurethane foam adds structural stability and prevents sinking. Heavy wall ss volute.

Propeller - two-blade design precision cast, 316 ss, non-clog operation

Intake Cone/Anti-Vortex Cross - 304 ss, provides minimum headloss

Aqua-Jet® Unit Sizes and Dimensions

SS Series (stainless steel)

FSS Model	HP	RPM	Approx Ship Wt (lbs)	DIMENSIONS (inches)					Shaft Dia.
				A	B	C	D	E	
3900111	1	1800	325	34.69	8.5	4	7.5	46.75	.875
3900211	2	1800	325	34.69	8.5	4	7.5	46.75	.875
3900311	3	1800	525	44.13	8.5	5	11	59.5	1.250
3900511	5	1800	525	44.13	8.5	5.25	11	59.5	1.250
3900711	7.5	1800	625	46.63	8.5	6.75	11	59.5	1.250
3901011	10	1800	945	51.69	10.38	6	12	70	1.750
3901511	15	1800	970	55.63	10.38	6.25	12	70	1.750
3902011	20	1200	1,300	79.94*	27.5*	6.5	13.5	82.88	2.125
3902511	25	1200	1,350	80.81*	27.5*	6.75	13.5	82.88	2.125
3903011	30	1200	1,845	86.94	30.63*	9.5	14.88	94.5	2.125
3904011	40	1200	1,870	90.31	30.63*	10	14.88	94.5	2.500
3905411	50	1200	1,900	90.31	30.63	10.5	14.88	94.5	2.500
3905011	50	1200	2,850	101.06	40.69*	8.88	14.88	114.63	2.500
3906011	60	1200	3,000	102.81	40.69*	10	14.88	114.63	2.703
3907511	75	1200	3,000	102.81	40.69*	10	14.88	114.63	2.703
3910021	100	900	4,500	113.5	42.5*	9.5	17	131	3.930
3912511	125	900	5,240	125.5	46.5*	11.5	19	131	3.930
3915011	150	900	5,390	128	46.5*	11.65	19	131	3.930

Mooring Cable Dia.

3/16"

1/4"

3/8"

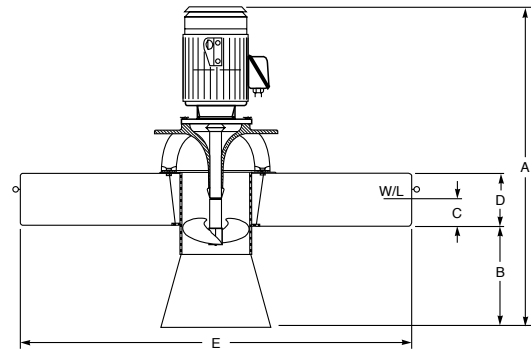

* Includes allowance for anti-vortex cross. Dual speed units are available upon request.

Typical Aqua-Jet® Aerator Operating Depths*

Activated Sludge

Unit Size (Horsepower)

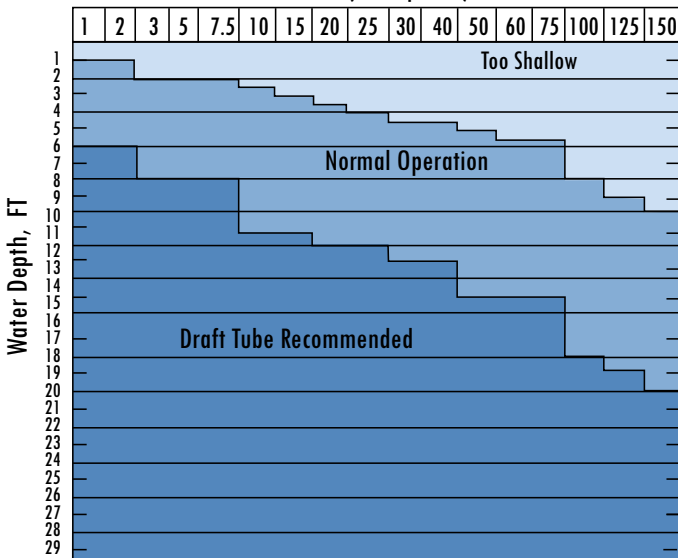

Aerated Lagoons

Unit Size (Horsepower)

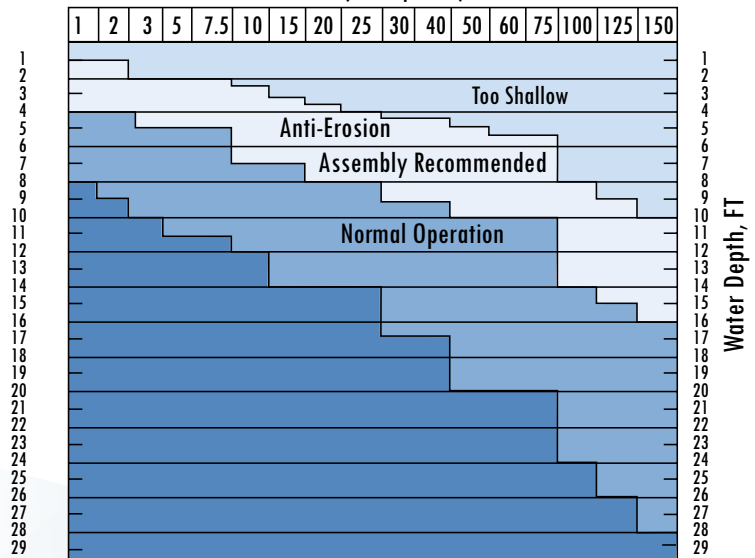

*These charts are intended for approximation purposes only. Requirements are dependent upon basin geometry. Consult Aqua-Aerobic Systems for larger horsepower units or specific applications.

Aqua-Jet® Accessory Options

Aqua-Jet II® Contained Flow Aerator

The Aqua-Jet II Contained Flow Aerator is designed for applications which require continued operation of aeration equipment during cold weather months, but are limited because of an inadequate heat sink due to process selection or environmental conditions. This aerator has proven to operate efficiently in a variety of applications, even in sub-zero temperatures. The dome is essentially a spray control shield mounted to the diffusion head of the Aqua-Jet aerator.

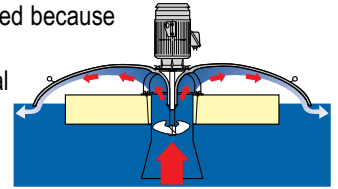

Anti-Erosion Assemblies

Anti-Erosion Assemblies consist of a stainless steel plate attached to the bottom of the Aqua-Jet aerator intake cone via an anti-vortex cross. The assembly causes water to be drawn from the sides of the intake cone, rather than from directly below it; and prevents damage to the basin liner or erosion of the bottom. Anti-Erosion Assemblies are available for all horsepower Aqua-Jet aerators. Consult your Aqua-Aerobic representative, or the factory for dimensions.

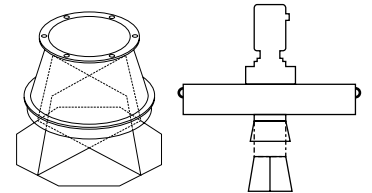

FSS Series (fiberglass)

FSS Model	HP	RPM	Approx Ship Wt (lbs)	DIMENSIONS (inches)					Shaft Dia.
				A	B	C	D	E	
4200111	1	1800	325	34.69	8.5	4	7	46.75	.875
4200211	2	1800	325	34.69	8.5	4	7	46.75	.875
4200311	3	1800	550	44.13	8.5	4	11	64	1.250
4200511	5	1800	550	44.13	8.5	5	11	64	1.250
4200711	7.5	1800	625	46.63	8.5	6	11	64	1.250
4201011	10	1800	900	51.69	10.38	5.5	12	71	1.750
4201511	15	1800	925	55.63	10.38	6	12	71	1.750
4202011	20	1200	1,100	79.94*	27.5*	7	14	84	2.125
4202511	25	1200	1,150	80.81*	27.5*	8	14	84	2.125
4203011	30	1200	1,845	86.94	*30	8	15.5	94.5	2.125
4204011	40	1200	1,845	90.31	*30	9	15.5	94.5	2.500
4205011	50	1200	1,900	90.31	*30	9	15.5	94.5	2.500
4205021	50	1200	2,350	101.06	40.69	5.5	15.25	114.75	2.500
4206011	60	1200	2700	102.81	40.69	6.25	15.25	114.75	2.703
4207517	75	1200	2700	102.81	40.69	6.25	15.25	114.75	2.703

Mooring Cable Dia. ↑ 3/16" ↓ 1/4" ↓

* Includes allowance for anti-vortex cross. Dual speed units are available upon request.

Aqua-Jet® Aerator Model SS-PW

- Ideal for Total Trihalomethane (TTHM) stripping in potable water applications with a minimum volume of 100,000 gallons
- Certified to NSF/ANSI 61 by UL
- Endura® Series high efficiency, low maintenance motors



Aqua-Jet® aerator model SS-PW in operation in a TTHM stripping application.

Draft Tubes

The Draft Tube accessory provides an extension of the intake cone and permits a deeper intake of water. Available in lengths of 3 and 6 feet.

Low Trajectory Diffuser (L.T.D.) Assembly

The Low Trajectory Diffuser (L.T.D.) Assembly is a high density polyethylene ring that is attached to the top of the diffusion head, increasing the diameter of the diffuser. This arrangement lowers the spray of the Aqua-Jet aerator reducing windblown spray and misting. Low trajectory diffusers are used in colder climates, and where a smaller, lower spray pattern is desired.

Arctic Pak

The Arctic Pak ring contains thermal resistance heaters which minimize the chance of icing on exposed surfaces of the Aqua-Jet aerator, such as the cast diffusion head. The Arctic Pak is complete with its own junction box (which mounts on the motor fan cover), automatic controls and control panel. Operation of the Arctic Pak is controlled by an ambient temperature thermostat.

The unit is available in either 230 or 460 volts, and can be used on either floating or fix-mounted Aqua-Jet aerators. Drawings and wiring diagrams are available on request. Contact your Aqua-Aerobic representative.



Aqua-Jet® Mooring Arrangements

There are four standard mooring arrangements for the Aqua-Jet aerator. The type selected is dependent on the specific application.

Post/Maintenance Mooring

A mooring post is installed on shore and the mooring line is attached to an eyebolt in the post. A maintenance loop enables the operator to pull the unit to shore or opposite side of the basin without disconnecting the line. Available for 3 or 4 point mooring.

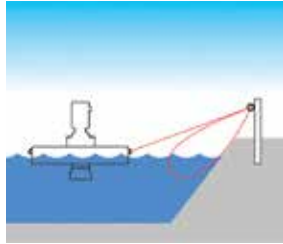

Span Mooring

Span Mooring is used in larger lagoon applications, allowing more than one (1) aerator to be attached to a single mooring cable across the lagoon. Each aerator is attached to the cable using a 3 point mooring concept and can be removed individually for service (*plan view shown to the right*).

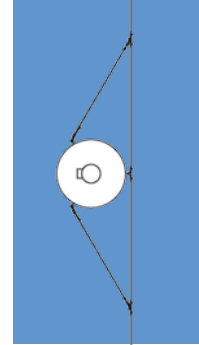

Restrained Mooring

Restrained Mooring is used in applications with varying water levels. The Aqua-Jet mooring frame fits around the mooring posts and allows the aerator to slide up and down the posts as the water level changes.

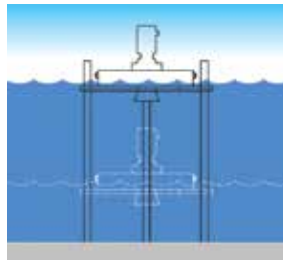

Pivotal Mooring

A Pivotal Mooring arm is used in applications with varying water levels with arm lengths up to 40 feet. The arm fits at the base of the motor allowing the aerator to adjust to varying water levels.

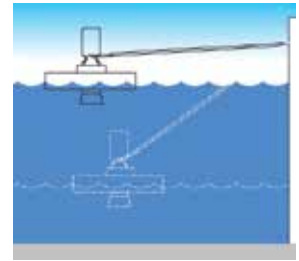

Aqua-Jet® Typical Applications

- Extended aeration
- Aerobic digestion
- Equalization
- Aerated lagoons
- Oxidation ditches
- Sludge holding
- Municipal-industrial combinations
- Batch reactor processes



Pulp and Paper Mills

- Simple and flexible installation
- Equipment is easily retrievable without dewatering basin
- Short lead times
- High efficiency motors reduce energy consumption
- Low installation cost
- Easily retrofitted into existing aeration systems



Digesters/Sludge Holding Basins

- Provides efficient oxygen transfer and complete mixing
- Pivotal Mooring or Restrained Mooring accommodates large changes in water level
- Units can be pulled to the side of the basin for service without dewatering
- Aerator can be cycled on/off to control dissolved oxygen (D.O.) and save energy

Providing **TOTAL** Water Management Solutions

Visit our website at www.aqua-aerobic.com to learn more about the Aqua-Jet® Surface Mechanical Aerator and our complete line of products and services:

Aeration & Mixing

Biological Processes

Filtration

Membrane Systems

Controls & Monitoring Systems

Aftermarket Products and Services



AQUA-AEROBIC SYSTEMS, INC.

6306 N. Alpine Rd Loves Park, IL 61111-7655

p 815.654.2501 f 815.654.2508

www.aqua-aerobic.com

solutions@aqua-aerobic.com

The information contained herein relative to data, dimensions and recommendations as to size, power and assembly are for purpose of estimation only. These values should not be assumed to be universally applicable to specific design problems. Particular designs, installations and plants may call for specific requirements. Consult Aqua-Aerobic Systems, Inc. for exact recommendations or specific needs. Patents Apply.